

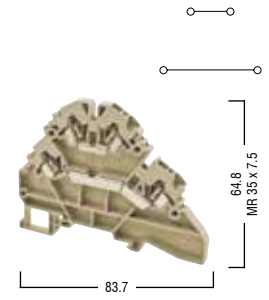





SCD 2.5 Series

Double Deck Spring Clamp Terminals



SCD2.5 Width 5mm

Electrical Ratings	
Voltage / Current / Cross Section	500V~ / 24A / 2.5mm ²
VDE	
UL/cUL	600V~ / 20A / AWG 22-12
Connection Data	
Insulation Stripping Length / Torque	10mm / ...
Solid Strand	0.5 - 4mm ²
Fine Strand, with Ferrule	0.5 - 2.5mm ²
AWG Conductor	22.....12
Ordering Data	
Electical Ratings	
Diode Reverse Voltage	
Diode Current	
Diode	
End Bracket	
For MR 32 & MR 35	 ES4
End Plate Partition	
Polyamide 66 - Thickness 1.2mm	 EPSCD2.5
Cross-Connection	
	 CCS2.5/2 CCS2.5/3 CCS2.5/4 CCS2.5/10
Test Plug	
	 TF2
Group Marking	
	 GM

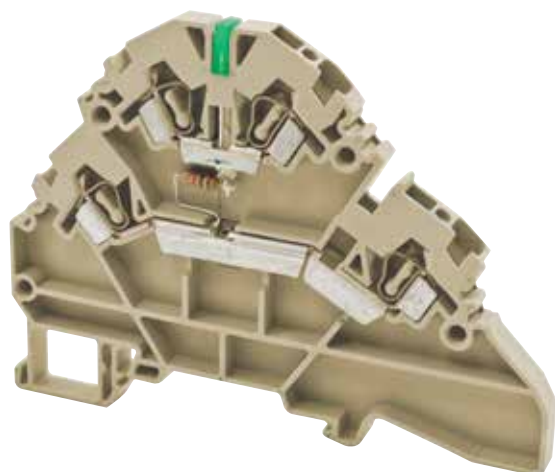

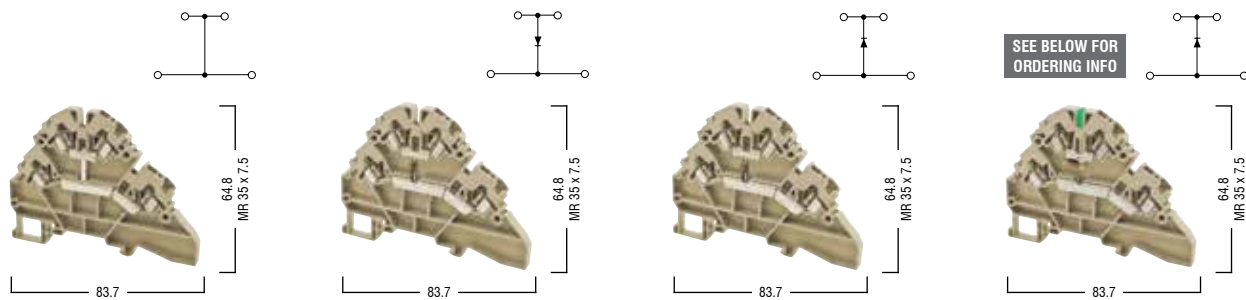







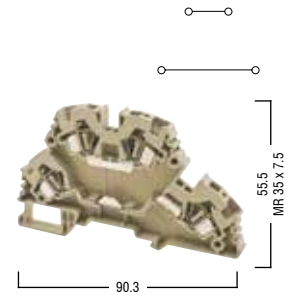

SCD2.5V	Width 5mm	SCD2.5D	Width 5mm	SCD2.5DR	Width 5mm	SCD2.5LD	Width 5mm
500V~ / 24A / 2.5mm ²		500V~ / 0.5A / 2.5mm ²		500V~ / 0.5A / 2.5mm ²		-V~ / 24A / 2.5mm ²	
10mm / ...		10mm / ...		10mm / ...		10mm / ...	
0.5 - 4mm ²		0.5 - 4mm ²		0.5 - 4mm ²		0.5 - 4mm ²	
0.5 - 2.5mm ²		0.5 - 2.5mm ²		0.5 - 2.5mm ²		0.5 - 2.5mm ²	
22.....12		22.....12		22.....12		22.....12	
						Type	Voltage AC
						SCD2.5LD24VAC	(24 VAC)
						SCD2.5LD24VDC	(24 VDC)
						SCD2.5LD48VAC	(48 VAC)
						SCD2.5LD48VDC	(48 VDC)
						SCD2.5LD110VAC	(110 VAC)
						SCD2.5LD110VDC	(110 VDC)
						SCD2.5LD220VAC	(220 VAC)
						SCD2.5LD220VDC	(220 VDC)
		1000V		1000V			
		1A		1A			
		1 N 4007		1 N 4007			
ES4		ES4		ES4		ES4	
EPSCD2.5		EPSC2.5		EPSC2.5		EPSC2.5	
CCS2.5/2		CCS2.5/2		CCS2.5/2		CCS2.5/2	
CCS2.5/3		CCS2.5/3		CCS2.5/3		CCS2.5/3	
CCS2.5/4		CCS2.5/4		CCS2.5/4		CCS2.5/4	
CCS2.5/10		CCS2.5/10		CCS2.5/10		CCS2.5/10	
TF2		TF2		TF2		TF2	
GM		GM		GM		GM	

SCD 4 Series

Double Deck Spring Clamp Terminals



SCD4 Width 6mm

Electrical Ratings	
Voltage / Current / Cross Section	750V~ / 32A / 4mm ²
VDE	
UL/cUL	600V~ / 26A / AWG 22-10
Connection Data	
Insulation Stripping Length / Torque	12mm / ...
Solid Strand	0.5 - 6mm ²
Fine Strand, with Ferrule	0.5 - 4mm ²
AWG Conductor	22.....10
Ordering Data	
Electical Ratings	
Diode Reverse Voltage	
Diode Current	
Diode	
End Bracket	
For MR 32 & MR 35	 ES4
End Plate Partition	
Polyamide 66 - Thickness 1.2mm	 EPSCD4
Cross-Connection	
	CCS4/2
	CCS4/3
	CCS4/4
	CCS4/10
Test Plug	
	TF2
Group Marking	
	GM



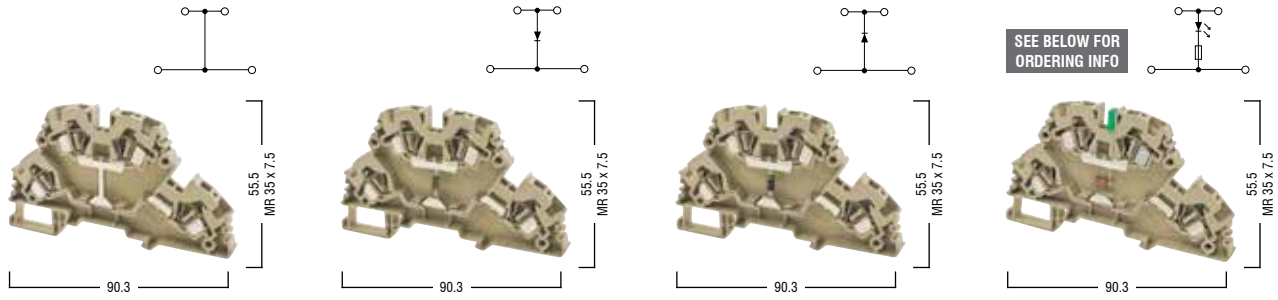

SCD4V	Width 6mm	SCD4D	Width 6mm	SCD4DR	Width 6mm	SCD4LD	Width 6mm
750V~ / 32A / 4mm ²		750V~ / 0.5A / 4mm ²		750V~ / 0.5A / 4mm ²		-V~ / 32A / 4mm ²	
						-V~ / 26A / AWG 22-10	
12mm / ...		12mm / ...		12mm / ...		12mm / ...	
0.5 - 6mm ²		0.5 - 6mm ²		0.5 - 6mm ²		0.5 - 6mm ²	
0.5 - 4mm ²		0.5 - 4mm ²		0.5 - 4mm ²		0.5 - 4mm ²	
22.....10		22.....10		22.....10		22.....10	
						Type	Voltage AC
						SCD4LD24VAC	(24 VAC)
						SCD4LD24VDC	(24 VDC)
						SCD4LD48VAC	(48 VAC)
						SCD4LD48VDC	(48 VDC)
						SCD4LD110VAC	(110 VAC)
						SCD4LD110VDC	(110 VDC)
						SCD4LD220VAC	(220 VAC)
						SCD4LD220VDC	(220 VDC)
		1000V		1000V			
		1A		1A			
		1 N 4007		1 N 4007			
ES4		ES4		ES4		ES4	
EPSCD4		EPSC4		EPSC4		EPSC4	
CCS4/2		CCS4/2		CCS4/2		CCS4/2	
CCS4/3		CCS4/3		CCS4/3		CCS4/3	
CCS4/4		CCS4/4		CCS4/4		CCS4/4	
CCS4/10		CCS4/10		CCS4/10		CCS4/10	
TF2		TF2		TF2		TF2	
GM		GM		GM		GM	